

Description

The DZRALTE-020L080 digital servo drive is designed to drive brushed and brushless servomotors, stepper motors, and AC induction motors from a compact form factor ideal for embedded applications. This fully digital drive operates in torque, velocity, or position mode and employs Space Vector Modulation (SVM), which results in higher bus voltage utilization and reduced heat dissipation compared to traditional PWM. The drive can be configured for a variety of external command signals. Commands can also be configured using the drive's built-in Motion Engine, an internal motion controller used with distributed motion applications. In addition to motor control, this drive features dedicated and programmable digital and analog inputs and outputs to enhance interfacing with external controllers and devices.

Network communication is accomplished using either RS-485/232 or Modbus RTU. This DZR Series drive features a single serial interface used for drive commissioning via DriveWare® 7, available for download at www.a-m-c.com.

The DZ Hardware Installation Manual is available for download from www.a-m-c.com. All drive and motor parameters are stored in non-volatile memory.

Power Range

Peak Current	20 A (14.1 A _{RMS})
Continuous Current	12 A (12 A _{RMS})
Supply Voltage	10 - 80 VDC

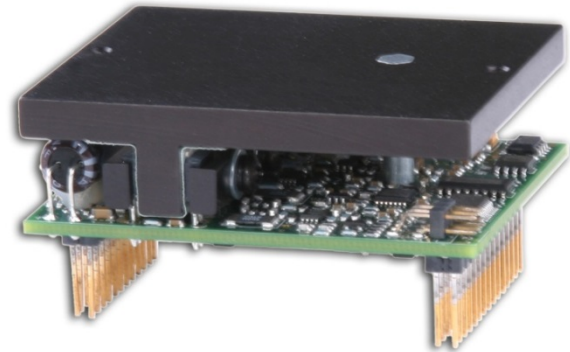

Features

- ▲ Four Quadrant Regenerative Operation
- ▲ Space Vector Modulation (SVM) Technology
- ▲ Fully Digital State-of-the-art Design
- ▲ Programmable Gain Settings
- ▲ Fully Configurable Current, Voltage, Velocity and Position Limits
- ▲ PIDF Velocity Loop
- ▲ PID + FF Position Loop
- ▲ Compact Size, High Power Density
- ▲ 12-bit Analog to Digital Hardware
- ▲ On-the-Fly Mode Switching
- ▲ On-the-Fly Gain Set Switching

MODES OF OPERATION

- Current
- Hall Velocity
- Position
- Velocity

COMMAND SOURCE

- PWM and Direction
- Encoder Following
- Over the Network
- ±10 V Analog
- 5V Step and Direction
- Sequencing
- Indexing
- Jogging

FEEDBACK SUPPORTED

- Halls
- Incremental Encoder
- ±10 VDC Position
- Auxiliary Incremental Encoder
- Tachometer (±10 VDC)

INPUTS/OUTPUTS

- 3 High Speed Captures
- 1 Programmable Analog Input (12-bit Resolution)
- 2 Programmable Digital Inputs (Differential)
- 3 Programmable Digital Inputs (Single-Ended)
- 3 Programmable Digital Outputs (Single-Ended)



COMPLIANCES & AGENCY APPROVALS

- UL
- cUL
- CE Class A (LVD)
- CE Class A (EMC)
- RoHS

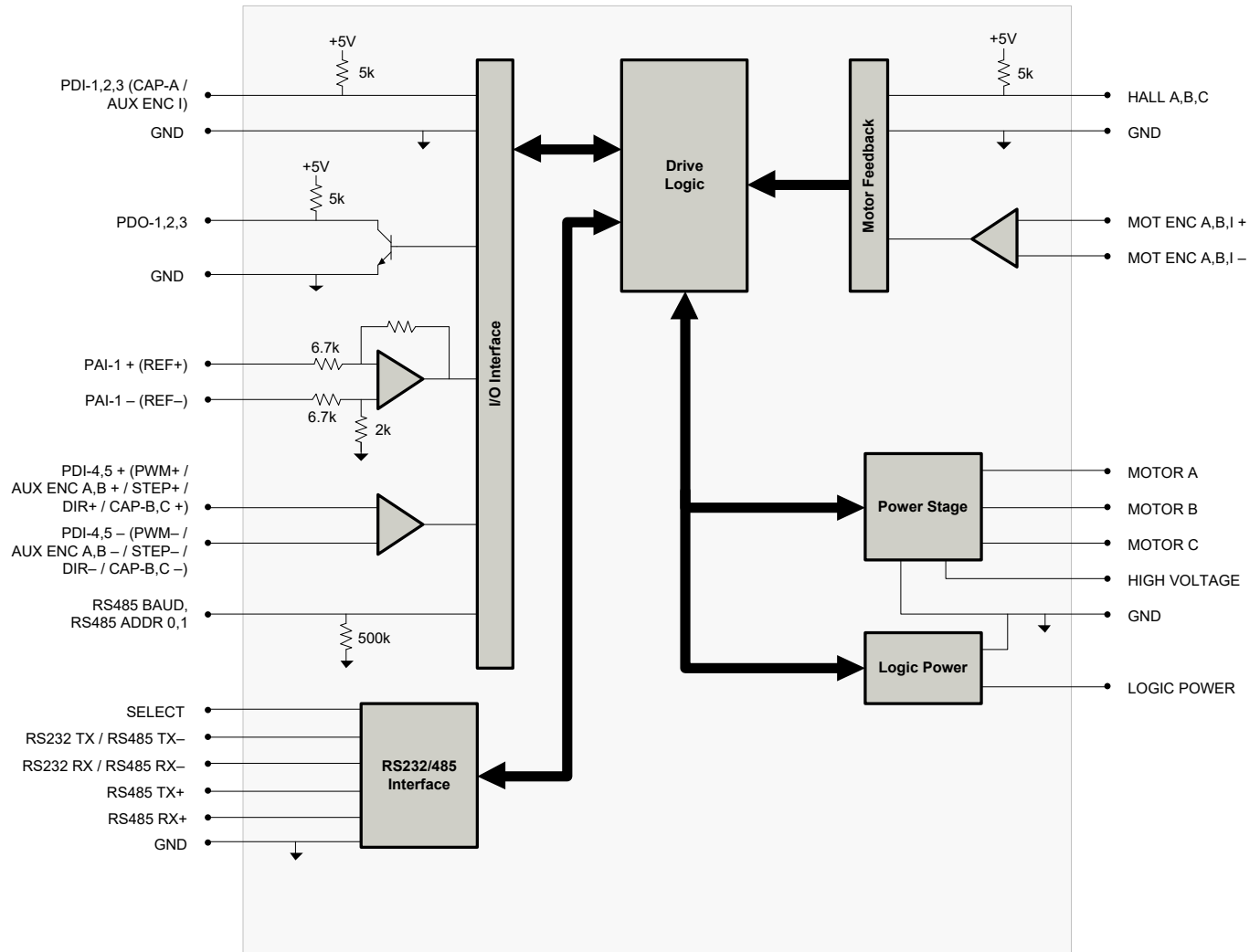
BLOCK DIAGRAM



Information on Approvals and Compliances

	<p>US and Canadian safety compliance with UL 508c, the industrial standard for power conversion electronics. UL registered under file number E140173. Note that machine components compliant with UL are considered UL registered as opposed to UL listed as would be the case for commercial products.</p>
	<p>Compliant with European EMC Directive 2014/30/EU on Electromagnetic Compatibility (specifically EN 61000-6-4:2007/A1:2011 for Emissions, Class A and EN 61000-6-2:2005 for Immunity, Performance Criteria A). LVD requirements of Directive 2014/35/EU (specifically, EN 60204-1:2006/A1:2009, a Low Voltage Directive to protect users from electrical shock).</p>
	<p>The RoHS Directive restricts the use of certain substances including lead, mercury, cadmium, hexavalent chromium and halogenated flame retardants PBB and PBDE in electronic equipment.</p>

SPECIFICATIONS

Power Specifications		
Description	Units	Value
DC Supply Voltage Range	VDC	10 - 80
DC Bus Over Voltage Limit	VDC	88
DC Bus Under Voltage Limit	VDC	8
Logic Supply Voltage	VDC	5 (+/- 5%)
Maximum Peak Output Current ¹	A (Arms)	20 (14.1)
Maximum Continuous Output Current ²	A (Arms)	12 (12)
Maximum Continuous Output Power	W	912
Maximum Power Dissipation at Continuous Current	W	48
Internal Bus Capacitance	µF	94
Minimum Load Inductance (Line-To-Line) ³	µH	250 (at 80 V supply); 150 (at 48 V supply); 75 (at 24 V supply); 40 (at 12 V supply)
Switching Frequency	kHz	20
Maximum Output PWM Duty Cycle	%	92
Control Specifications		
Description	Units	Value
Communication Interfaces	-	RS-485/232 / Modbus RTU
Command Sources	-	±10 V Analog, 5V Step and Direction, Encoder Following, Over the Network, PWM and Direction, Sequencing, Indexing, Jogging
Feedback Supported	-	±10 VDC Position, Auxiliary Incremental Encoder, Halls, Incremental Encoder, Tachometer (±10 VDC)
Commutation Methods	-	Sinusoidal, Trapezoidal
Modes of Operation	-	Current, Hall Velocity, Position, Velocity
Motors Supported ⁴	-	Three Phase (Brushless Servo), Single Phase (Brushed Servo, Voice Coil, Inductive Load), Stepper (2- or 3-Phase Closed Loop), AC Induction (Closed Loop Vector)
Hardware Protection	-	40+ Configurable Functions, Over Current, Over Temperature (Drive & Motor), Over Voltage, Short Circuit (Phase-Phase & Phase-Ground), Under Voltage
Programmable Digital Inputs/Outputs (PDIs/PDOs)	-	5/3
Programmable Analog Inputs/Outputs (PAIs/PAOs)	-	1/0
Primary I/O Logic Level	-	5V TTL
Current Loop Sample Time	µs	50
Velocity Loop Sample Time	µs	100
Position Loop Sample Time	µs	100
Maximum Encoder Frequency	MHz	20 (5 pre-quadrature)
Mechanical Specifications		
Description	Units	Value
Agency Approvals	-	CE Class A (EMC), CE Class A (LVD), cUL, RoHS, UL
Size (H x W x D)	mm (in)	63.5 x 50.8 x 22.9 (2.5 x 2.0 x 0.9)
Weight	g (oz)	105 (3.7)
Heatsink (Base) Temperature Range ⁵	°C (°F)	0 - 75 (32 - 167)
Storage Temperature Range	°C (°F)	-40 - 85 (-40 - 185)
Cooling System	-	Natural Convection
Form Factor	-	PCB Mounted
P1 Connector	-	30-pin, 2.54 mm spaced, dual-row header
P2 Connector	-	24-pin, 2.54 mm spaced, dual-row header

Notes

1. Capable of supplying drive rated peak current for 2 seconds with 10 second foldback to continuous value. Longer times are possible with lower current limits.
2. Continuous I_{Arms} value attainable when RMS Charge-Based Limiting is used.
3. Lower inductance is acceptable for bus voltages well below maximum. Use external inductance to meet requirements.
4. Maximum motor speed for stepper motors is 600 RPM. Consult the hardware installation manual for 2-phase stepper wiring configuration.
5. Additional cooling and/or heatsink may be required to achieve rated performance.

PIN FUNCTIONS

P1 - Signal Connector				
Pin	Name	Description / Notes	I/O	
1	RS485 ADDR 0	RS-485 Network Address Selector	I	
2	RS485 ADDR 1		I	
3	PAI-1 + (REF+)		I	
4	PAI-1 - (REF-)	Differential Programmable Analog Input or Reference Signal Input (12-bit Resolution)	I	
5	GND		GND	
6	RS485 BAUD	RS-485 Baud Rate Selector	I	
7	PDO-1	Programmable Digital Output	O	
8	PDO-2	Programmable Digital Output	O	
9	PDO-3	Programmable Digital Output	O	
10	PDI-1	Programmable Digital Input	I	
11	PDI-2	Programmable Digital Input	I	
12	PDI-3 (CAP-A / AUX ENC I)	Programmable Digital Input or High Speed Capture or Auxiliary Encoder Index	I	
13	RS232 RX / RS485 RX-	Receive Line (RS-232 or RS-485)	I	
14	RS485 RX+	Receive Line (RS-485)	I	
15	RS232 TX / RS485 TX-	Transmit Line (RS-232 or RS-485)	O	
16	RS485 TX+	Transmit Line (RS-485)	O	
17	PDI-4 + (PWM+ / STEP+ / AUX ENC A+ / CAP-B+)	Programmable Digital Input or PWM or Step+ or Auxiliary Encoder or High Speed Capture (For Single-Ended Signals see DZ HW Installation Manual)	I	
18	PDI-4 - (PWM- / STEP- / AUX ENC A- / CAP-B-)		I	
19	PDI-5 + (DIR+ / AUX ENC B+ / CAP-C+)	Programmable Digital Input or Direction or Auxiliary Encoder or High Speed Capture (For Single-Ended Signals see DZ HW Installation Manual)	I	
20	PDI-5 - (DIR- / AUX ENC B- / CAP-C-)		I	
21	GND	Ground	GND	
22	HALL A	Single-ended Commutation Sensor Input (For Differential Inputs See MC1XDZ02 Datasheet For Recommended Signal Conditioning)	I	
23	HALL B		I	
24	HALL C		I	
25	MOT ENC I+	Differential Encoder Index Input (See MC1XDZ02 Datasheet For Recommended Signal Conditioning)	I	
26	MOT ENC I-		I	
27	MOT ENC A+	Differential Encoder A Channel Input (See MC1XDZ02 Datasheet For Recommended Signal Conditioning)	I	
28	MOT ENC A-		I	
29	MOT ENC B+	Differential Encoder B Channel Input (See MC1XDZ02 Datasheet For Recommended Signal Conditioning)	I	
30	MOT ENC B-		I	

P2 - Power Connector				
Pin	Name	Description / Notes	I/O	
1a	LOGIC PWR	Logic Supply Input	I	
1b	RESERVED	Reserved	-	
2a	2b	GND	GND	
3a	3b	GND	GND	
4a	4b	HIGH VOLTAGE	I	
5a	5b	HIGH VOLTAGE	I	
6a	6b	RESERVED	-	
7a	7b	MOTOR C	O	
8a	8b	MOTOR C	O	
9a	9b	MOTOR B	O	
10a	10b	MOTOR B	O	
11a	11b	MOTOR A	O	
12a	12b	MOTOR A	O	

Pin Details
RS485 ADDR 0 (P1-1)

This pin, RS485 ADDR 0, as well as RS485 ADDR 1, are used for RS-485 network addressing. To set the address of a drive, use the formula

$$RS485\ Address = \frac{7 * Addr0}{3} + 8 * \frac{7 * Addr1}{3},$$

where *RS485Address* is the desired node address and *Addr0* and *Addr1* represent the voltage that should be applied to pins RS485 ADDR 0 and RS485 ADDR 1, respectively. The values for *Addr0* and *Addr1* are always integer multiples of 3/7 V within the range 0-3 V. Examples of the voltages required to set certain node addresses are given in the table below. Note that setting a drive address of 0 will utilize the address stored in non-volatile memory.

RS485 ADDR 0 Value (V)	RS485 ADDR 1 Value (V)	RS485 ADDR Tolerance (V)	RS485 Address (Address #)
0	0	±0.1	Address stored in non-volatile memory
3/7 (0.43)	0	±0.1	1
6/7 (0.86)	0	±0.1	2
9/7 (1.3)	0	±0.1	3
...	...	±0.1	...
18/7 (2.57)	21/7 (3.0)	±0.1	62
21/7 (3.0)	21/7 (3.0)	±0.1	63

RS485 BAUD (P1-6)

The RS-485 baud rate is set by applying the appropriate voltage to the RS485 BAUD pin as given in the table below.

RS485 BAUD Value (V)	RS485 BAUD Tolerance (V)	RS485 Baud Rate (bits/s)
0	±0.388	Bit rate stored in non-volatile memory
1	±0.388	9.6k
2	±0.388	38.4k
3	±0.388	115.2k

HARDWARE SETTINGS

Jumper Settings

Jumper	Description	Configuration		
		Not Installed	Pins 1-2	Pins 2-3
J1	Reserved.	-	-	N/A
J2	Reserved.	-	-	N/A
J3	RS-485 selection. Install this jumper (2mm) to select RS-485 communication. This jumper is located on a 6-pin header between the PCB and heatsink. It consists of the two pins closest to the corner of the PCB.	RS-232	RS-485	N/A

MECHANICAL INFORMATION

P1 - Signal Connector

Connector Information	30-pin, 2.54 mm spaced, dual-row header	
Mating Connector	Details	Samtec: SSM-115-L-DV (SMT); BCS-115-L-D-PE (Pass-through)
	Included with Drive	No

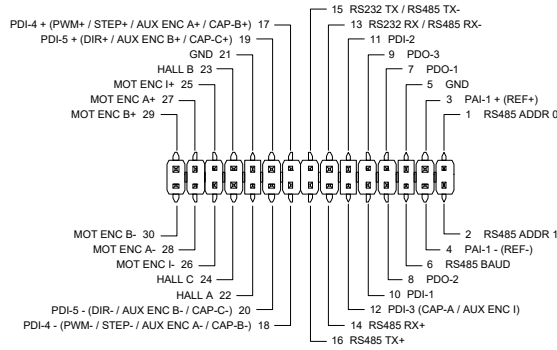

P2 - Power Connector

Connector Information	24-pin, 2.54 mm spaced, dual-row header	
Mating Connector	Details	Samtec: SSM-112-L-DV (SMT); BCS-112-L-D-PE (Pass-through)
	Included with Drive	No

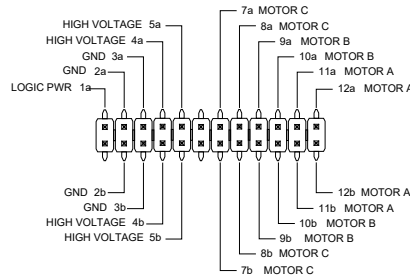

MOUNTING DIMENSIONS

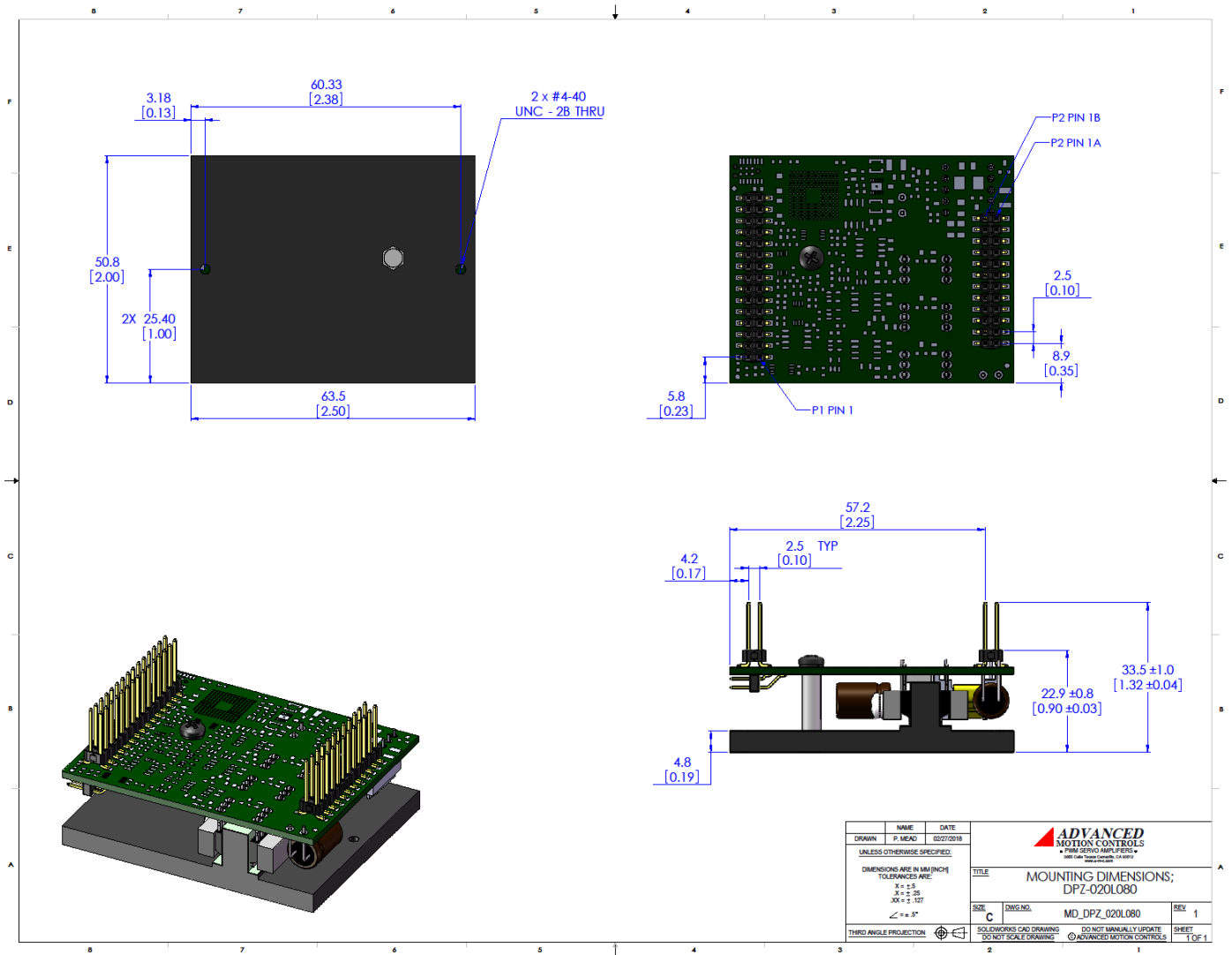

PART NUMBERING INFORMATION

Example: **D Z R A L T E - 0 2 0 L 0 8 0**

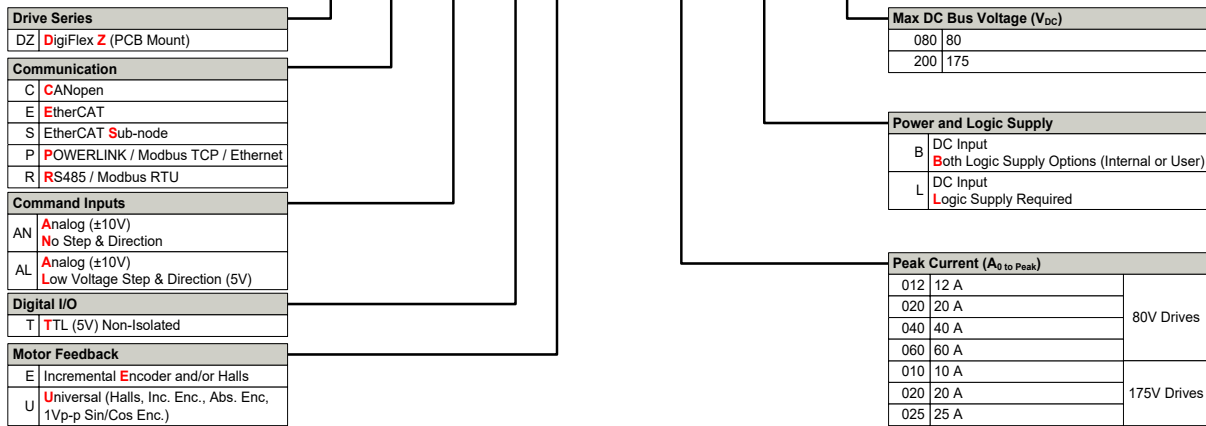

DigiFlex® Performance™ series of products are available in many configurations. Note that not all possible part number combinations are offered as standard drives. All models listed in the selection tables of the website are readily available, standard product offerings.

ADVANCED Motion Controls also has the capability to promptly develop and deliver specified products for OEMs with volume requests. Our Applications and Engineering Departments will work closely with your design team through all stages of development in order to provide the best servo drive solution for your system. Equipped with on-site manufacturing for quick-turn customs capabilities, ADVANCED Motion Controls utilizes our years of engineering and manufacturing expertise to decrease your costs and time-to-market while increasing system quality and reliability. Feel free to contact Applications Engineering for further information and details.

Examples of Customized Products

- ▲ Optimized Footprint
- ▲ Private Label Software
- ▲ OEM Specified Connectors
- ▲ No Outer Case
- ▲ Increased Current Resolution
- ▲ Increased Temperature Range
- ▲ Custom Control Interface
- ▲ Integrated System I/O
- ▲ Tailored Project File
- ▲ Silkscreen Branding
- ▲ Optimized Base Plate
- ▲ Increased Current Limits
- ▲ Increased Voltage Range
- ▲ Conformal Coating
- ▲ Multi-Axis Configurations
- ▲ Reduced Profile Size and Weight

Available Accessories

ADVANCED Motion Controls offers a variety of accessories designed to facilitate drive integration into a servo system. Visit www.a-m-c.com to see which accessories will assist with your application design and implementation.

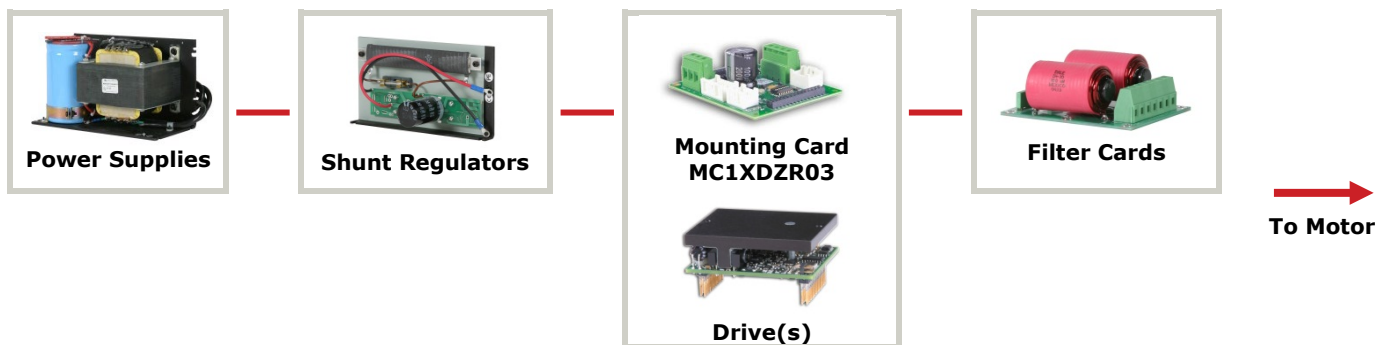

All specifications in this document are subject to change without written notice. Actual product may differ from pictures provided in this document.